

FilterBox 12A

Automatically cleaned for medium to heavier dust & fume applications.



The FilterBox 12A is equipped with a powerful fan for a maximum air flow capacity of 1 200 m³/h (700 CFM). An integrated silencer reduces noise from the fan and outlet air. The unit has an advanced filter control system with automatic cleaning that starts when the air flow is too low. Available either as a mobile unit on wheels or attached to a floor stand. Additional protection from harmful particles is provided if a HEPA filter is installed.

For dust applications, the unit is cleaned mechanically. For welding fumes it uses a combination of mechanical and compressed air cleaning.

For welding applications, compressed air cleaning is required.













Note! FilterBox is not for use in environments where combustible dust or gases are present, and it is not for use in filtering combustible dust or gases.

- User friendly and superior filter cleaning, mechanical and/or with compressed air for long filter life
- Automatic damper preventing dust from leaking out while cleaning
- Dust free filter replacement and emptying of dust bin
- Third party approval for welding fumes category W3 according to EN 15012-1

Product name	FilterBox 12A
Noise level (dB(A))	74
Protection class	IP 54
Filter efficiency (%)	99
Compressed air requirement	DIN ISO 8573-1, class 5/5/4 (7 bar)
Installation	[Indoor]
Material	Casing in rotomoulded plastic
Dustbin volume (l)	15
Extraction arm diameter (mm)	160
Airflow (m³/h)	1200
Filter Area (m²)	13
Frequency (Hz)	50
No of phases	3
Filter type	[cartridge]
Number of filter elements	1
Filter material	Polyester PW13
Electric plug	without
Power (kW)	2,2
Note	Mechanical filter cleaning only













FilterBox 12A

Image	Description	Power Voltage (V)	Arm length (m)	Mounting	Weight (kg)	Filter cleaning method	Model
	FilterBox 12 A	400	3 (Original)		115	Mechanical ,Compressed air	12662563
	FilterBox 12 A	200	3 (Original)		115	Mechanical ,Compressed air	12679663
	FilterBox 12 A	200	3 (Original)		112	Mechanical ,Compressed air	12679763
	FilterBox 12 A.	230	3 (Original)		115	Mechanical	12661963*
	FilterBox 12 A.	230	3 (Original)		112	Mechanical	12662063*
	FilterBox 12 A.	400	3 (Original)		115	Mechanical	12662163*
	FilterBox 12 A.	400	3 (Original)		112	Mechanical	12662263*
	FilterBox 12 A	230	3 (Original)		115	Mechanical ,Compressed air	12662363
	FilterBox 12 A	230	3 (Original)		112	Mechanical ,Compressed air	12662463
	FilterBox 12 A	400	3 (Original)		112	Mechanical ,Compressed air	12662663
	FilterBox 12 A.	400	Without		112	Mechanical	12686463*
	FilterBox 12 A	400	Without		115	Mechanical ,Compressed air	12687163
	FilterBox 12 A.	400	Without		115	Mechanical	12687263*
	FilterBox 12 A.	400	Without		112	Mechanical ,Compressed air	12685263

*Mechanical filter cleaning only

FilterBox 12A

Accessory		Part No
	Outlet with duct connection D=200mm	12376749
	Spotlight original, (LED) 24V, 5W	12376616*
	LED light/fan switch Original	10376922
	Spark protection for Original/NEX MD-hood	10551335
	Filter-PW-FB-13	12332672
	Filter-PW HE-FB-15	12371106
	Filter PWA-FB-15	12371412
	HEPA filter H13 10m2 Filterbox	12376615
	Bags for Filterbox dust bin, 10pcs	12376618
	HEPA filter H14 10m2 Filterbox	12376756
	Sensor clamp to be attached to the earth cable of the welding power source.	14372199
	Twin Module blue	12376801

*Switch for light (no fan start)

FilterBox 12A

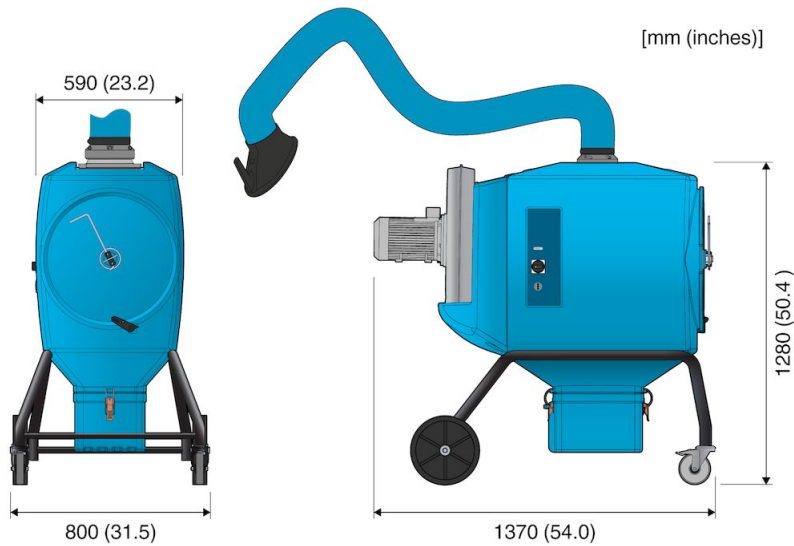

FilterBox 12M. Mobile

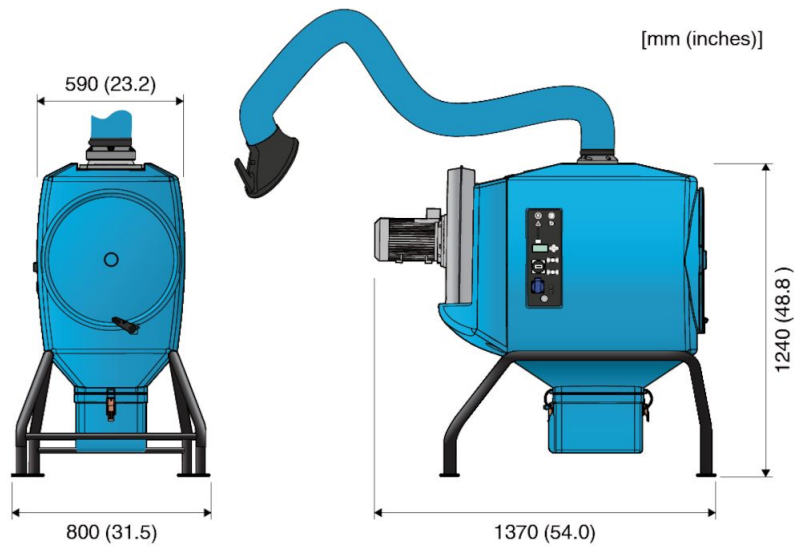

Floor mounted FilterBox 12A